

Article number: 12317000140160  
Description: KLEE-coil 317 000 140.160  
M14 Hardened/zinc-plated slotted pin

## Measures

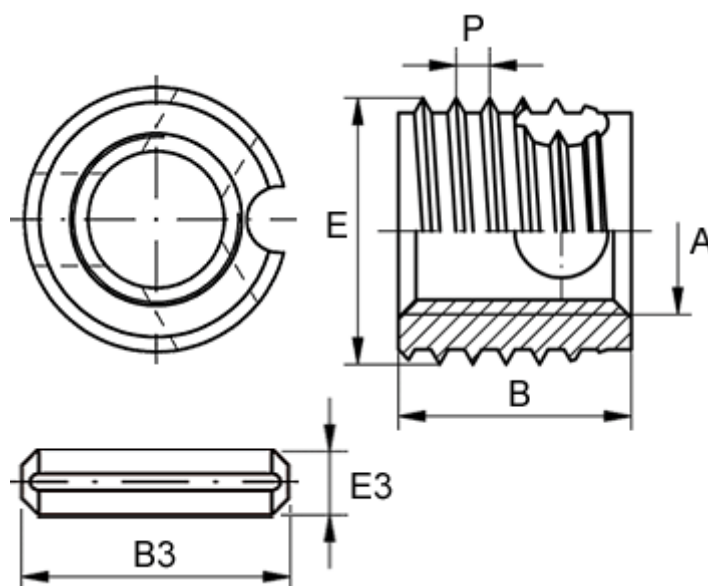

Female thread A	= M14
Length B	= 14
Male thread E	= 18.0
Min hole depth blind hole	= 17
Slotted pin B3	= 10
Slotted pin E3	= 2
Thread pitch P	= 2.00
Type	= 317 000 140 ...